

MSRRCD - Maximum Security Risk Resistant Ceiling Diffuser

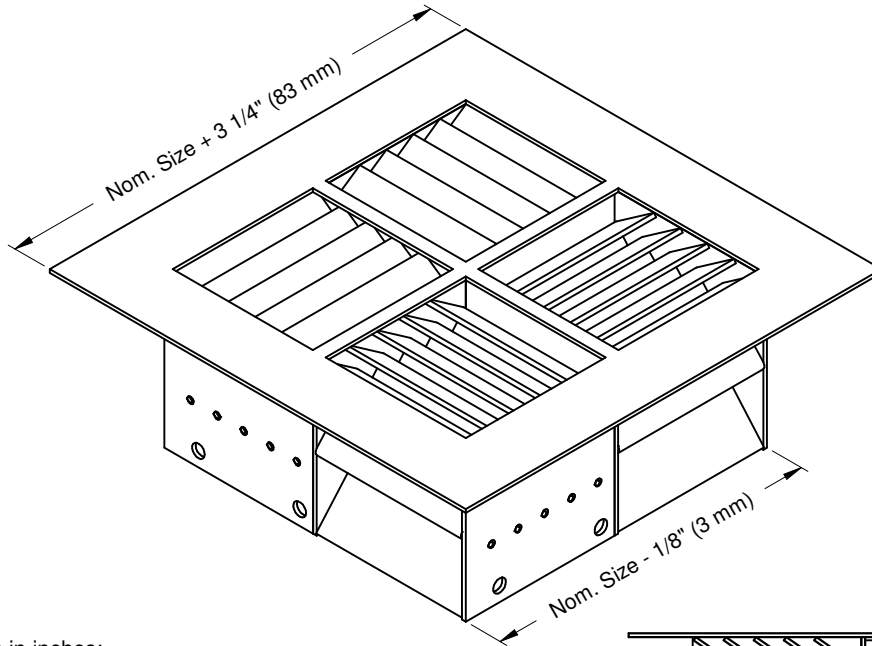

SIZES:

- Available sizes in inches:
 - 6" x 6" (152mm x 152mm) (Available in 1-Way pattern only)
 - 8" x 8" (203mm x 203mm)
 - 9" x 9" (229mm x 229mm)
 - 10" x 10" (254mm x 254mm)
 - 12" x 12" (305mm x 305mm)
 - 15" x 15" (381mm x 381mm)
 - 16" x 16" (406mm x 406mm)
 - 18" x 18" (457mm x 457mm)

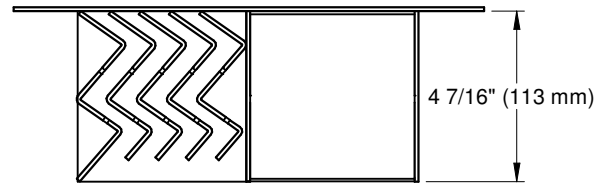

SLEEVE:

- 4 7/16" (113 mm) deep modular core stitch welded
- S12 - Optional 12 gauge steel sleeve extension, stitch welded to diffuser
Overall sleeve length with extension - 6" (152 mm) min., 24" (610 mm) max.

STANDARD CONSTRUCTION:

- 12 Gauge hot rolled steel construction

LOUVERS:

- 35 Deg. deflection blades
- 5/16" (8 mm) Blade spacing

STANDARD FINISH:

- B12 - Standard White
- Optional Finishes Available:
 - Optional Colors
 - Custom Colors
- See finishes brochure for additional information.
- Contact your PRICE representative for leadtimes and pricing.



NOTES:

- Accepted by New York State Office of Mental Health for high risk areas. See NYSOMH Patient Safety Standards for Guidelines.
- For installations that are not poured/built in place, recommended opening is Nom. Size + 1/4" (6mm)

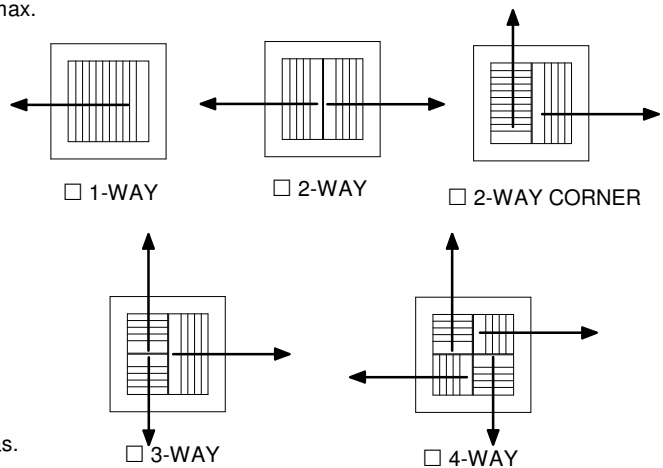
AVAILABLE AIR PATTERNS:



ALL METRIC DIMENSIONS () ARE SOFT CONVERTED. IMPERIAL DIMENSIONS ARE CONVERTED TO METRIC AND ROUNDED TO THE NEAREST MILLIMETER.

PROJECT:		
ENGINEER:		
CUSTOMER:		 242075
SUBMITTAL DATE:	SPEC. SYMBOL:	2021/08/05

MSRRCD
MAXIMUM SECURITY
RISK RESISTANT
CEILING DIFFUSER

MSRRCD - Maximum Security Risk Resistant Ceiling Diffuser

FASTENING OPTIONS:

MF1
1" x 1" x 3/16"
(25mm x 25mm x 5mm)
angle frame

MF3
1" x 1" x 1/8"
(25mm x 25mm x 3mm)
angle frame

MF2
1 1/2" x 1 1/2" x 3/16"
(38mm x 38mm x 5mm)
angle frame

MF4
1 1/2" x 1 1/2" x 1/8"
(38mm x 38mm x 3mm)
angle frame

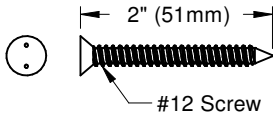
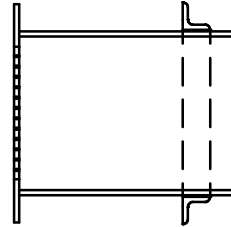

CS12-SPNR
Countersunk screwholes in face with tamper-proof plated steel spanner screws # 12 x 2" (51 mm)

CS12-SPNR-SS
Countersunk holes in face with tamper-proof stainless steel spanner screws # 12 x 2" (51 mm)

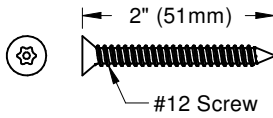
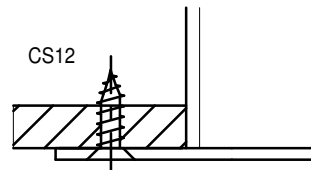

CS12-TORX
Countersunk holes in face with tamper-proof plated steel TORX screws # 12 x 2" (51 mm)

CS12-TORX-SS
Countersunk holes in face with tamper-proof stainless steel TORX screws # 12 x 2" (51 mm)

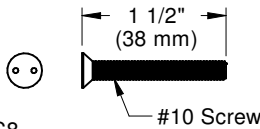
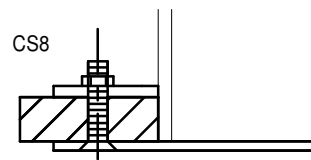

CS8
Rear angle frame with # 10-24 x 1 1/2" (38 mm) tamper-proof screws, spanner head, with threaded mounting plate

- Screwdriver bits, handles and replacement screws for CS fastening options may be ordered under GRD-PARTS model code



Scan for link to additional product information and installation instructions.

ALL METRIC DIMENSIONS () ARE SOFT CONVERTED. IMPERIAL DIMENSIONS ARE CONVERTED TO METRIC AND ROUNDED TO THE NEAREST MILLIMETER.

PROJECT:		PRICE
ENGINEER:		
CUSTOMER:		<i>MJ</i>
SUBMITTAL DATE:		242075
SPEC. SYMBOL:		2021/08/05
		MSRRCD MAXIMUM SECURITY RISK RESISTANT CEILING DIFFUSER